

 **KORAMIC**

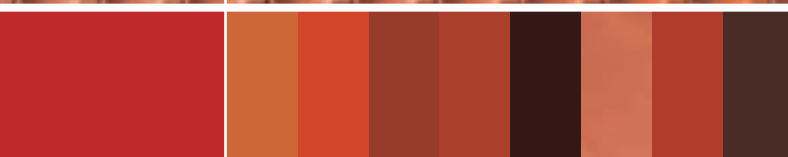

**Reformziegel  
Z18S**



 **Wienerberger**

# Reformziegel Z18S



- Klare, horizontale Linienführung ergibt ruhige, harmonische Dachlandschaften
- Besonders für Sanierungen geeignet, weil die große Verschiebbarkeit kaum Änderungen in der Dachkonstruktion erfordert
- Dachziegelmodell für traditionelle und moderne Dachgestaltung; lieferbar in bewährten und modernen Farben
- Einfache, unsichtbare Firstbefestigung; schnell und sicher zu verlegen

## Regeldachneigung

### Zulässige Dachneigung ohne erhöhte Anforderung

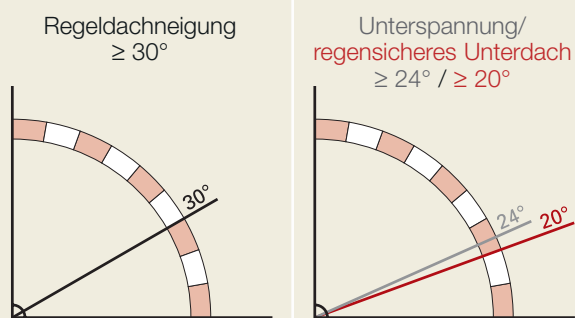

## Farben

### Naturrot



naturrot

### Engobe



rot engobiert



altrot



kupfer



altschwarz



nuanciert

### Edelengobe



edel klinkerrot



edelschwarz

## Form

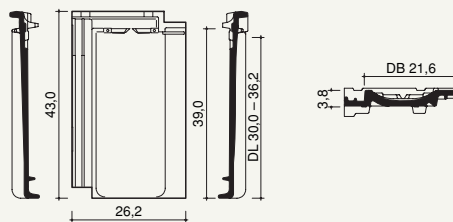

## Technische Daten

Bedarf Stück/m <sup>2</sup> (ca.):	12,8–15,5
Decklänge cm (ca.):	30,0–36,2
Mittlere Decklänge (ca.):	33,1
Deckbreite cm (ca.):	21,6
Größe cm (ca.):	26,2 x 43,0
Gewicht kg/Stück (ca.):	3,5
Gewicht kg/m <sup>2</sup> (ca.):	44,8
Stück/Paket:	6
Stück/Palette:	240
Regeldachneigung:	30°

**First Nr. 40 (2,5 Stück/m) bis 35° Neigung**

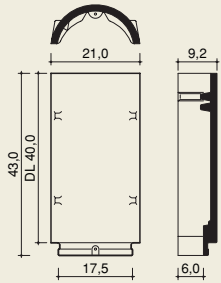

**First-Anfang-Endziegel Nr. 40**

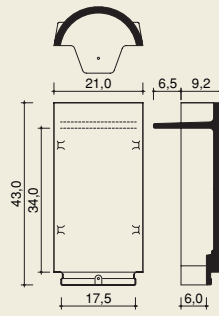

**First Nr. 60 (2,5 Stück/m)**

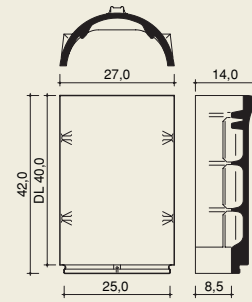

**First-Anfang-Endziegel Nr. 60**

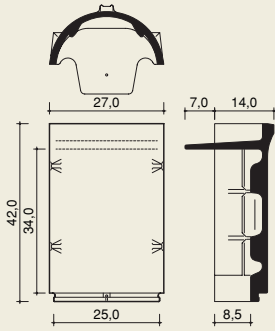

**Pultdachfirst (3,0 Stück/m)**

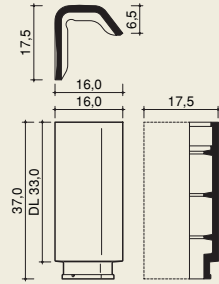

**Pultdach-Abschlusscheibe (Anfang/Ende)**

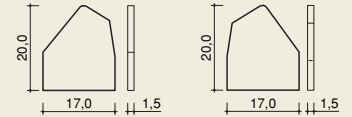

**Walmkappe Universal I (dreiachsig)**

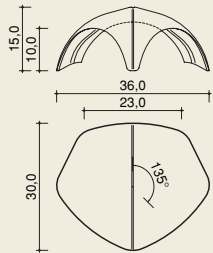

**Walmkappe Universal III (dreiachsig)**

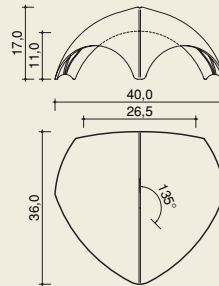

**Ortgangziegel, links (3,0 Stück/m)**

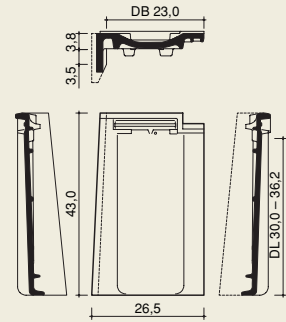

**Ortgangziegel, rechts (3,0 Stück/m)**

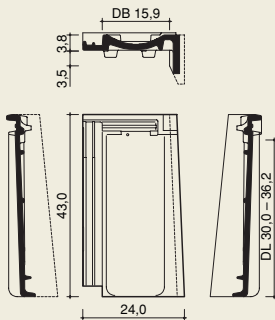

**Doppelwulstziegel (3,0 Stück/m)**

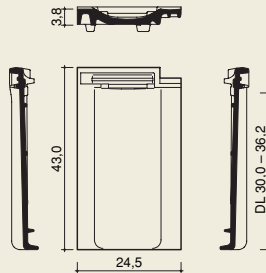

**Firstanschlussziegel**

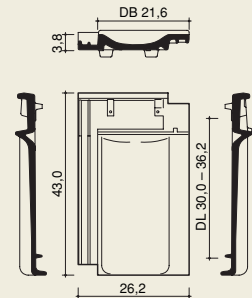

### Lüfterziegel (LQ ca. 18,0 cm<sup>2</sup>)

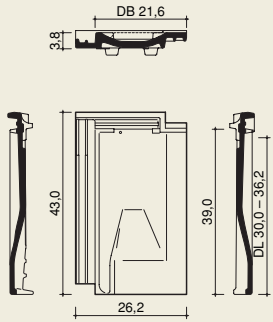

### Dunstrohrdurchgang 100 mm, schlagregensicher (Ton)

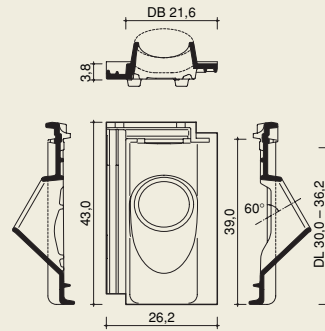

### Dunstrohr

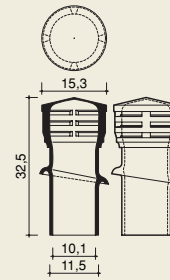

### Weiteres Zubehör ohne Abbildung:

- Flächenziegel, längshalb
- Firstanschluss-Ortgang links, rechts
- Dunstrohrsystem Ton 125 mm, NEU
- Dunstrohrsystem PVC
- Antennensystem Ton
- Antennensystem PVC
- Solar-Durchgangziegel
- Acrylpfanne

# Reformziegel Z18S



## First – Detail

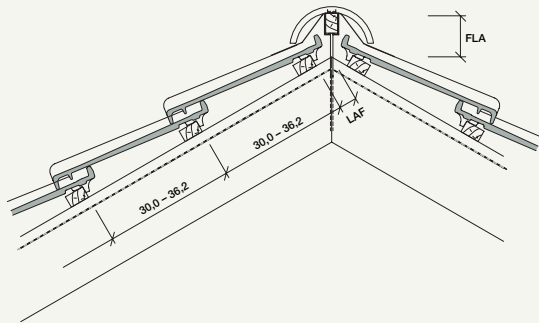

### Abluft am First

≥ 0,5 ‰ der zugehörigen Dachfläche,  
jedoch mindestens 50 cm<sup>2</sup>/m First

First Nr. 60 mit Firstanschlussziegel

DN°	15°	20°	25°	30°	35°	40°	45°	50°	55°
LAF in cm	-	-	-	7,5	7,5	7,5	8,0	-	-
FLA in cm	-	-	-	8,5	8,0	7,5	6,5	-	-

Die angegebenen Maße gelten für Dachlatten mit dem Querschnitt 30 x 50 mm.

First Nr. 40 mit Firstanschlussziegel

DN°	15°	20°	25°	30°	35°	40°	45°	50°	55°
LAF in cm	-	-	-	4,5	4,5	-	-	-	-
FLA in cm	-	-	-	7,5	7,5	-	-	-	-

Die angegebenen Maße gelten für Dachlatten mit dem Querschnitt 30 x 50 mm.

## Trauf – Detail

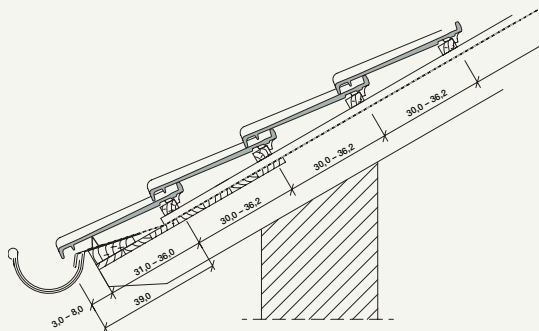

### Zuluft an der Traufe

≥ 2 ‰ der zugehörigen Dachfläche,  
jedoch mindestens 200 cm<sup>2</sup>/m Traufe

Traufenüberstand nach örtlichen Gegebenheiten,  
Sparrenlänge, Dachneigung und Rinnengröße bauseits  
ermitteln (variabel 3,0–8,0 cm)

Abstand Traufe zur 1. Lattung  
39,0 cm abzüglich Traufüberstand = 31,0–36,0 cm

## Ortgang – Detail mit Ortgangziegel

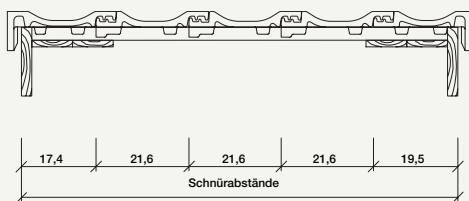

## Ortgang – Detail mit Doppelwulstziegel

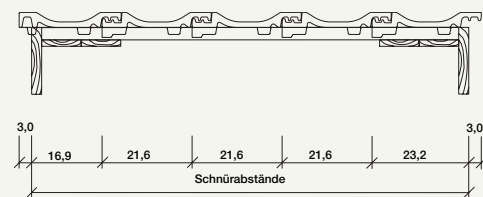



Abb. oben li.: ziegelrot, Abb. oben re.: naturrot, Abb. unten: ziegelrot

Koramic Dachprodukte GmbH & Co. KG  
Oldenburger Allee 26 • D-30659 Hannover  
T 05 11 - 69 60 30 9 - 0  
F 05 11 - 69 60 30 99  
[www.koramic.de](http://www.koramic.de)